



## Assembly and Operation Instructions

### Metal Base for Height Adjustable Desk







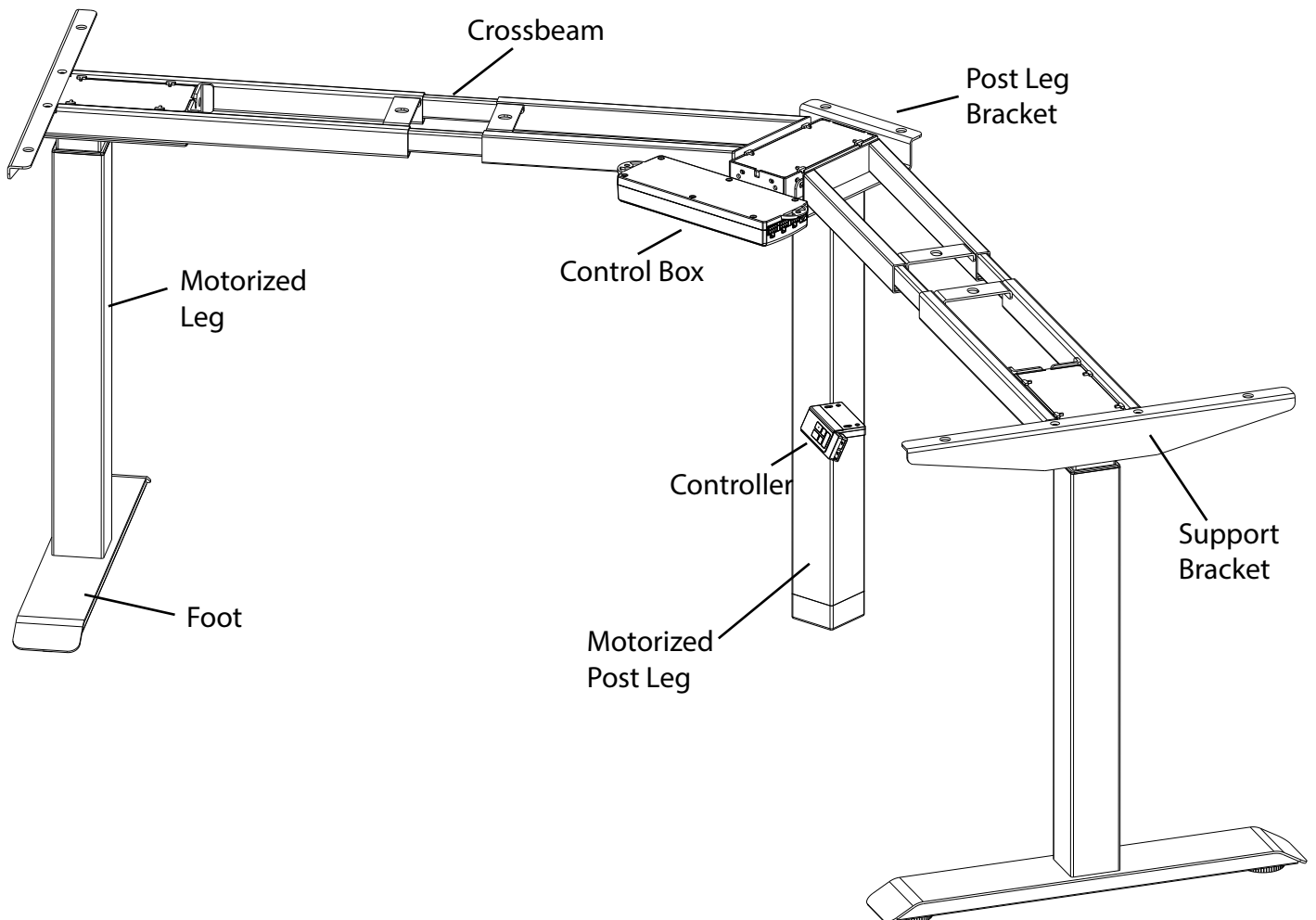















OFD-CI2ELBASE-120-BS\*

OFD-CI2ELBASE-120-WH\*

OFD-CI2ELBASE-120-BLK\*



## COMPONENTS AND TOOLS

REFERENCE	TYPE	QUANTITY	ITEM
<b><u>PIECES</u></b>			
<b>A</b>	<b>M6*10 screw</b>	<b>16</b>	
<b>B</b>	<b>M6*12 screw</b>	<b>12</b>	
<b>C</b>	<b>M8*16 screw</b>	<b>8</b>	
<b>D</b>	<b>M8*10 screw</b>	<b>4</b>	
<b>E</b>	<b>M6*16 screw</b>	<b>4</b>	
<b>F</b>	<b>ST4.8*19 self-tapping screw</b>	<b>2</b>	
<b>G</b>	<b>ST3.5*19 self-tapping screw</b>	<b>2</b>	
<b>H</b>	<b>ST4.8*25 self-tapping screw</b>	<b>10</b>	
<b>I</b>	<b>Plastic Pad</b>	<b>10</b>	
<b>J</b>	<b>Rubber Cushion</b>	<b>10</b>	
<b><u>PARTS</u></b>			
	<b>Control Box</b>	<b>1</b>	
	<b>Controller</b>	<b>1</b>	
	<b>Power Cord</b>	<b>1</b>	
	<b>Crossbeam</b>	<b>2</b>	
	<b>Motorized Leg</b>	<b>2</b>	
	<b>Motorized Post Leg</b>	<b>1</b>	
	<b>Post Leg Bracket</b>	<b>1</b>	
	<b>Support Bracket</b>	<b>2</b>	
	<b>Foot</b>	<b>2</b>	
<b><u>TOOLS</u></b>			
	<b>4mm Allen Key</b>	<b>1</b>	
	<b>5mm Allen Key</b>	<b>1</b>	
	<b>Adhesive Cable Ties</b>	<b>5</b>	
	<b>Drill/Driver</b>	<b>Not Included</b>	

# ASSEMBLY INSTRUCTIONS

(2 people recommended)

## STEP 1:

Attach post leg bracket to the post leg using **(4) x E screws**

Tool Required:  
5mm Allen Key

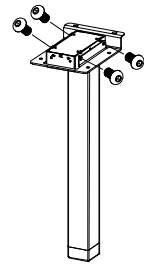

## STEP 2:

Place (2) x crossbeams on stable surface and attach each leg using **(8) x B screws**  
(4 screws for each leg)

Tool Required:  
4mm Allen Key

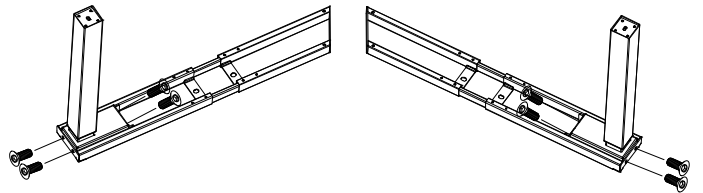

## STEP 3:

Attach post leg to each crossbeam using **(4) x D screws**

Tool Required:  
5mm Allen Key

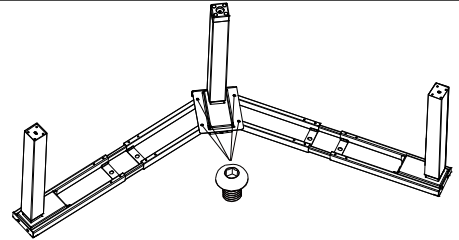

## STEP 4:

Attach each foot to each leg using **(8) x C screws**  
(4 screws for each foot)

Tool Required:  
5mm Allen Key

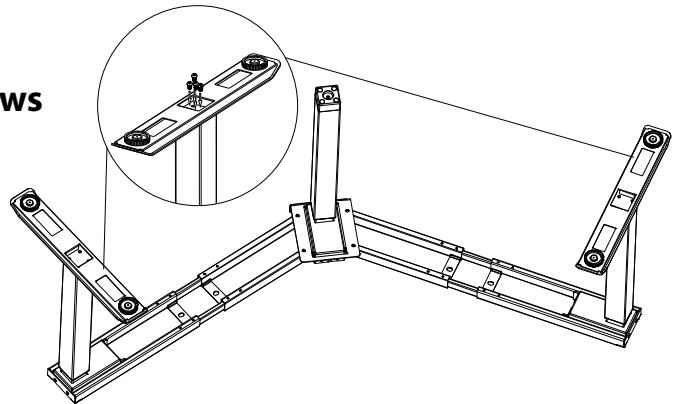

## STEP 5:

Turn frame over and attach both support brackets using **(4) x B screws**  
Place **(2) rubber cushions** and **(2) plastic pads** on each support bracket  
and **(2)** of each at each crossbeam and **(2)** of each at post leg bracket as shown in image.  
(10 rubber cushions and 10 plastic pads total)

Tool Required:  
4mm Allen Key

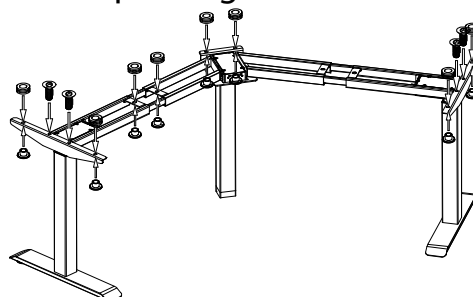

### **STEP 6:**

Turn frame over and place on underside of desktop.  
Adjust crossbeams so frame is centered and inset  
2 inches from each end of desktop edge.  
Use 2 x(8) x **A screws** to lock frame  
adjustment into place. (16 screws total)

Tool Required:  
4mm Allen Key 

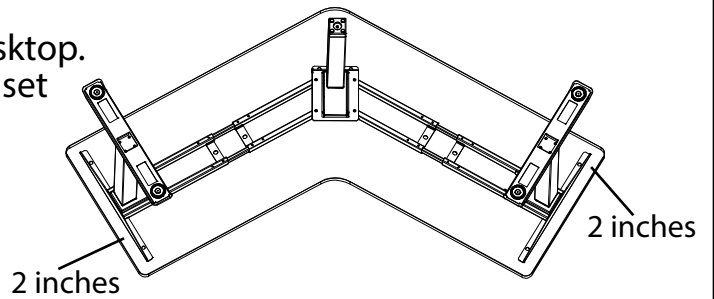

### **STEP 7:**

Secure frame to desktop using (2) x **H screws**  
at each crossbeam, (2) at each bracket,  
and (2) at post leg bracket.  
(10 screws total)

Tool Required:  
Drill/Driver

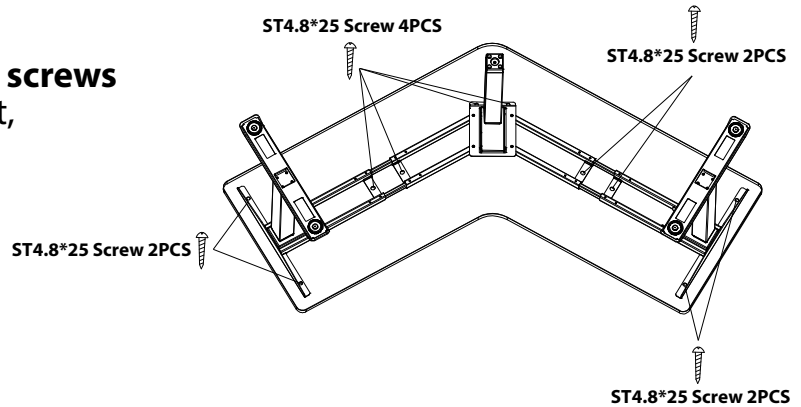

### **STEP 8:**

A. Attach control box using (2) x **F screws**

B. Attach controller using (2) x **G screws**

Tool Required:  
Drill/Driver

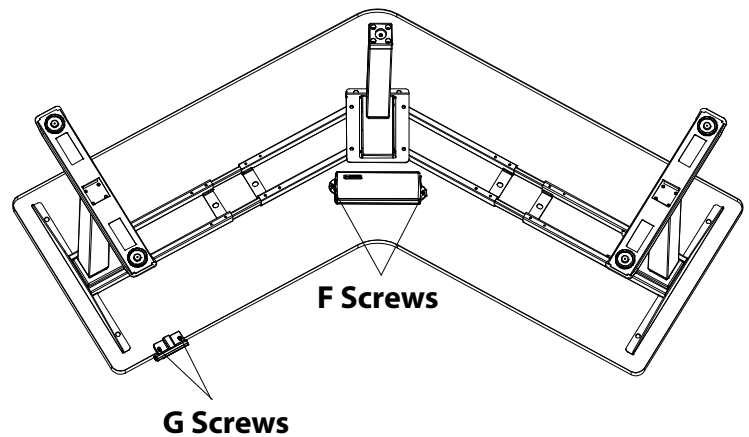

### **STEP 9:**

Return desk to upright position.

Connect power cord, controller cable,  
and each of the motorized leg cables  
to the control box.

**Please see the steps for System  
Initialization on next page to  
complete set up.**

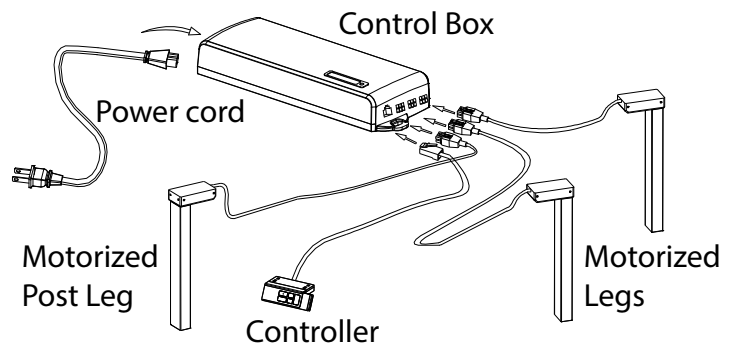

## **SYSTEM INITIALIZATION**

**After assembly of desk is complete, it is necessary to reset or initialize the motor system.**



### **STEP 1:**

Plug the power cord into an outlet or power strip. *(Display will flash)*

### **STEP 2:**

Press and **continue holding** both the **up** (Λ) and **down** (∇) buttons simultaneously until the desk is at its lowest point, *the display will flash "000" followed by a beep and the display will then show the lowest height. (The buttons can now be released)*

### **NOTE:**

If initialization is interrupted by releasing buttons prematurely *(display will read "000")* and/or if desk does not begin moving, repeat step 2.

### **STEP 3:**

Press the **up** (Λ) button to raise the desk to the highest position. *(Now release the button)*

### **STEP 4:**

Press the **down** (∇) button to lower the desk to the lowest position. *(Now release the button)*

*(The system has now been successfully initialized and synced)*

---

## **INSTALACION DE CONTROL DE MESA Y SINCRONIZACION**

**DESPUES DE COMPLETAR EL ENSAMBLAJE ES NECESARIO REINICIAR O INICIALIZAR EL SISTEMA DEL MOTOR, POFAVOR DE SEGUIR LOS SIGUIENTES PASOS:**

### **PASO 1:**

Conecte el cable de corriente en el enchufe. *(la pantalla va a prender)*

### **PASO 2:**

Presione los botones de (Λ) arriba y (∇) abajo al mismo tiempo hasta que las patas de las columna esten en su punto mas bajo y continúe presionando los botones hasta que *la pantalla ensene "000". Luego sonara un pitido y la pantalla mostrara el numero de la medida mas baja, despues de haber echo esto suelta los botones.*

### **NOTA:**

Si la inicializacion se interrumpe al soltar los botones prematuramente la pantalla mostrara "000" o si no se mueve, repita el paso dos.

### **PASO 3:**

Presione el boton de arriba (Λ) para elevar la mesa ala posicion mas alta, despues he haber echo esto suelta el boton.

### **PASO 4:**

Presione el boton de abajo (∇) para elevar la mesa ala posicion mas baja, despues he haber echo esto suelta el boton.

*(El sistema se ha inicializado y sincronizado con exito)*

# **HEIGHT ADJUSTABLE BASE** **OPERATION GUIDE**



## **METRIC OR IMPERIAL HEIGHT SETTING:**

**The controller can show either Metric (cm) or Imperial (in) height.**

### **STEP 1:**

Press the **(1) (2) (3)** buttons simultaneously for 5 seconds until “C-I” appears on the display.  
*Now Release the buttons.*

### **STEP 2:**

Press the **(1)** button to show Metric height or press the **(2)** button for the Imperial mode.

*(The height setting is now complete.)*

## **SETTING THE MEMORY FUNCTION:**

### **STEP 1:**

Use the up (Λ) and down (∨) buttons to reach the desired height of the desk.

### **STEP 2:**

Press and hold the up (Λ) and **(1)** button until display reads “P1”.  
*(Position 1 is now memorized.)*

*Follow the same procedure for memory preset 2 and 3 by pressing the up (Λ) and **(2)** or **(3)** button for the 2nd and 3rd memory positions.*

*(Display will read “P2” and “P3” when the 2nd and 3rd positions have been memorized)*

*(Memorized positions will remain even if power is lost.)*

## **NORMAL OPERATION:**

Raise or lower the desk by pressing and holding the up (Λ) or down (∨) button on the Controller until the desired height is reached.

**USB Function:** Connect desired USB compatible device to USB port to charge.

## **NOTES:**

\*Keep base away from water and corrosion-resistant gas.

\*Use this base with actual technical parameters.

\*Please contact Office Furniture Distributors with any problems or issues at:  
cs@ofdist.com or 972-386-5200/Toll Free: 866-648-3635