











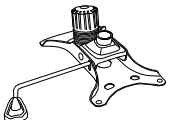
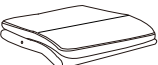

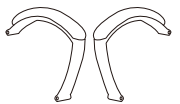
# Office Furniture Distributors

Model Number : OFD6300-BLK

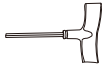
(1)	(2)	(3)
		
Caster : 5 pcs	5-Star Base : 1 pc	Gas Lift : 1 pc
(4)	(5)	(6)
		
Mechanism : 1 pc	Seat Cushion : 1 pc	Back Cushion : 1 pc
(7)	(8)	
		
Arm Rest : 2 pcs	Side Frame : 2 pcs	
<b>Hardware</b>		
A	B	C
		
Screw : 4 pcs	Screw : 4 pcs	Screw : 4 pcs
D	E	F
		
Wrench : 1 pc	External : 1 pc	Cap : 4 pcs

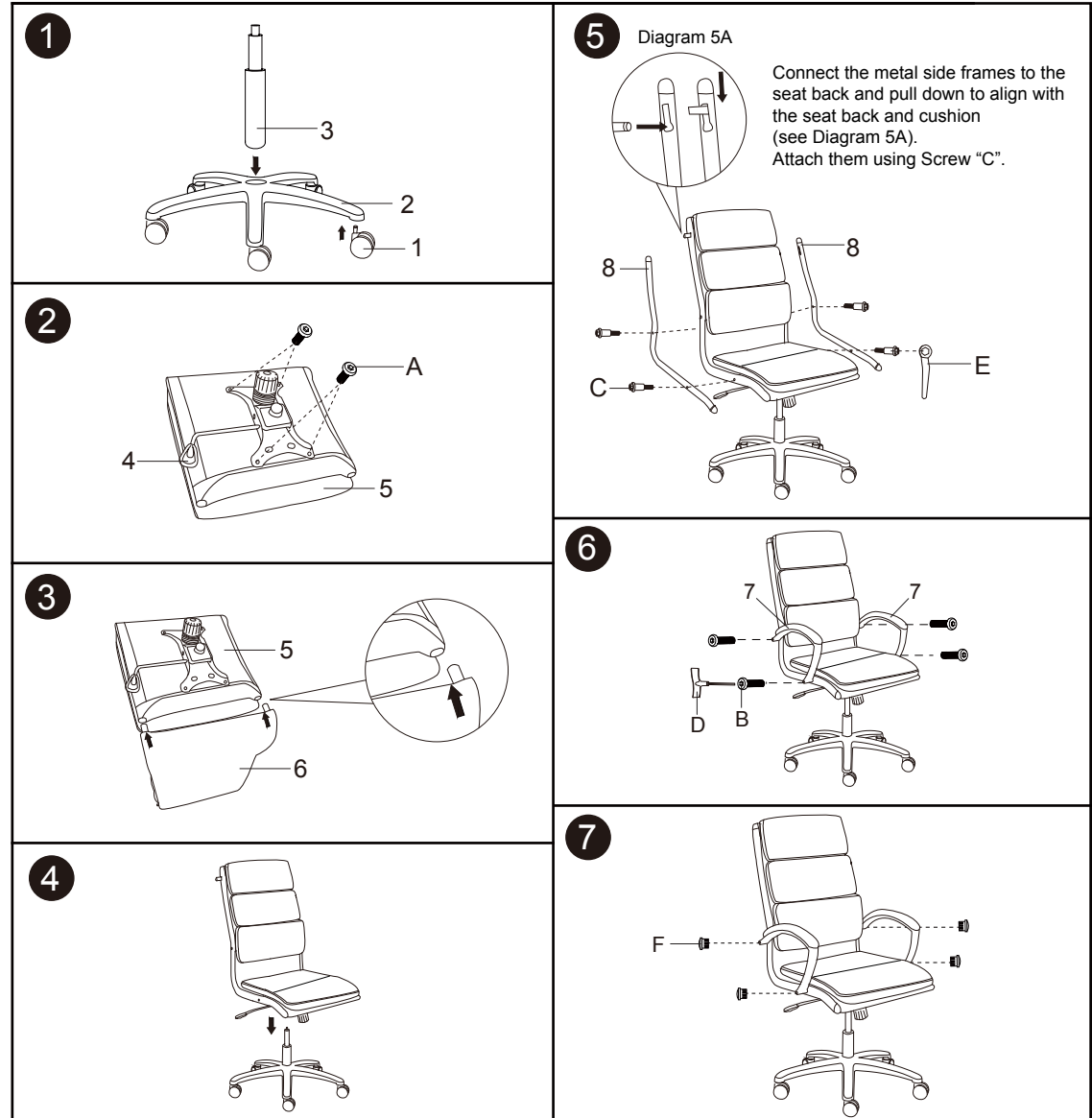

Customer Service : 1-866-648-3635