

# ASSEMBLY INSTRUCTION

## SI1109-BLK

BEFORE USE AND ASSEMBLY THIS PRODUCT, PLEASE READ THIS INSTRUCTION CAREFULLY

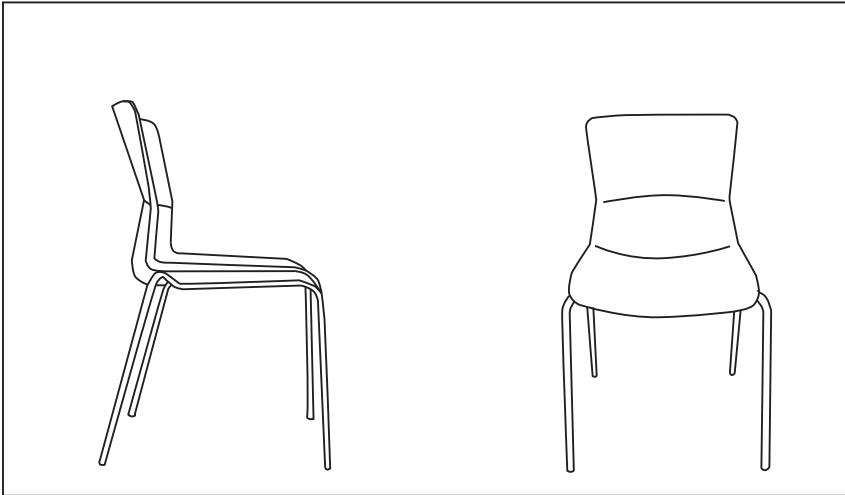

A\*1

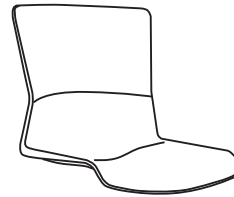

B\*1

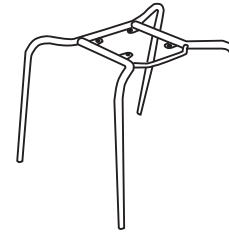

C\*1

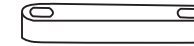

D\*2(M6\*14)

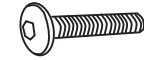

E\*2(M6\*12)

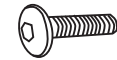

F\*1



1

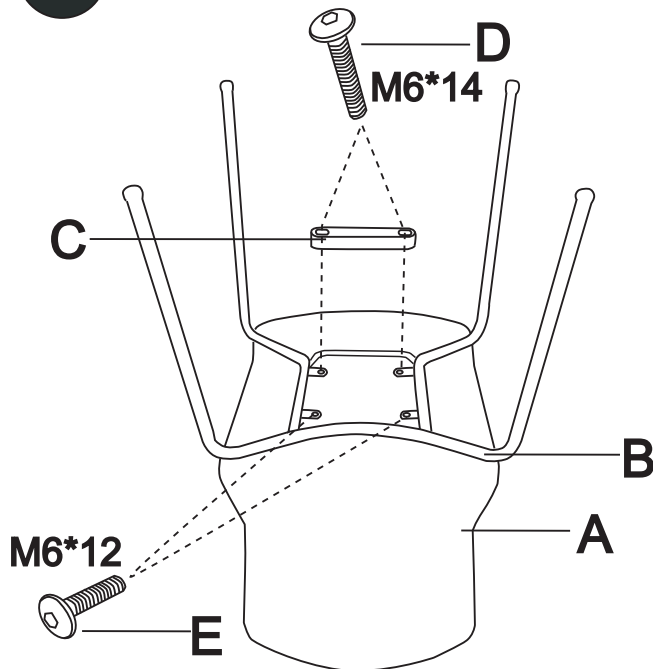

2



## WARNING

**FAILURE TO FOLLOW THESE INSTRUCTIONS  
MAY RESULT IN SERIOUS INJURY**

1. THIS PRODUCT IS DESIGNED FOR SEATING ONLY. DO NOT STAND ON THIS PRODUCT. DO NOT USE IT AS A STEP LADDER
2. DO NOT USE THIS PRODUCT UNLESS ALL BOLTS AND PARTS ARE FIRMLY TIGHTENED. AT LEAST WITHIN 3 MONTHS, YOU HAVE TO CHECK ALL THE PARTS FOR SAFETY USE.
3. IF ANY PARTS ARE MISSING, DAMAGED OR WORN, STOP USING THIS PRODUCT, REPAIR THE PRODUCT WITH MANUFACTURER'S SUPPLIED PARTS.
4. DO NOT SIT ON THE ARMREST OF THIS PRODUCT.
5. THIS PRODUCT IS DESIGNED FOR SITTING ONE PERSON AT A TIME.
6. CHILDREN UNDER THE AGE OF 10, PLEASE USE UNDER ADULT SUPERVISION.