

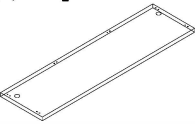

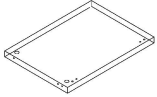
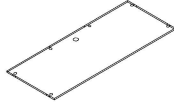
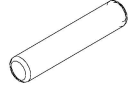
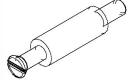

(1) Top  1PCS	(2) End Panel  2PCS	(3) Modesty Panel  1PCS	(A) Dowel  10PCS+1	(B) Cam Pin  10PCS+1	(C) Cam Lock  10PCS+1	(D) Cam Cover  10PCS+1	(E) Leg leveler  4PCS	(F) Grommet  3PCS
--	---	---	--	--	--	--	---	---

### STEP 3

### STEP 1

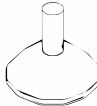

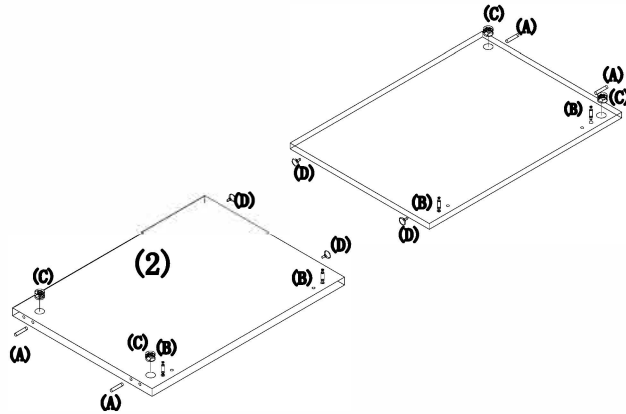
### STEP 2

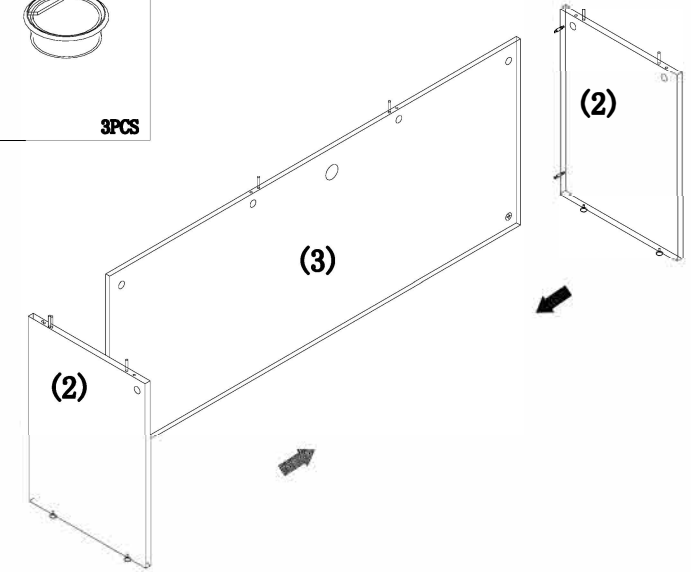
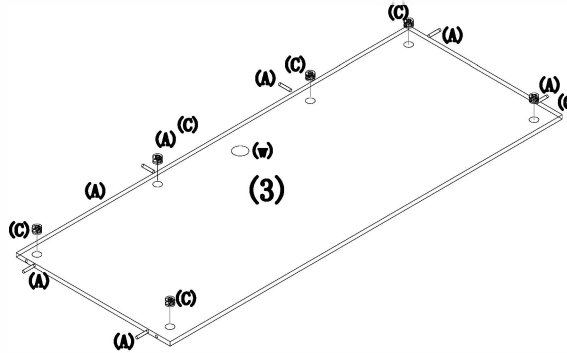

### STEP 4

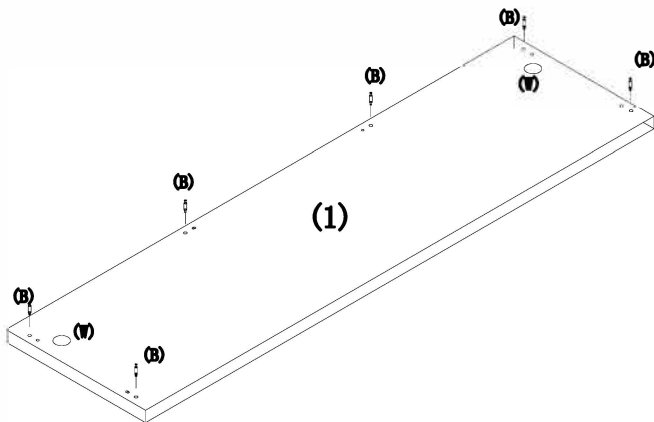

### STEP 5

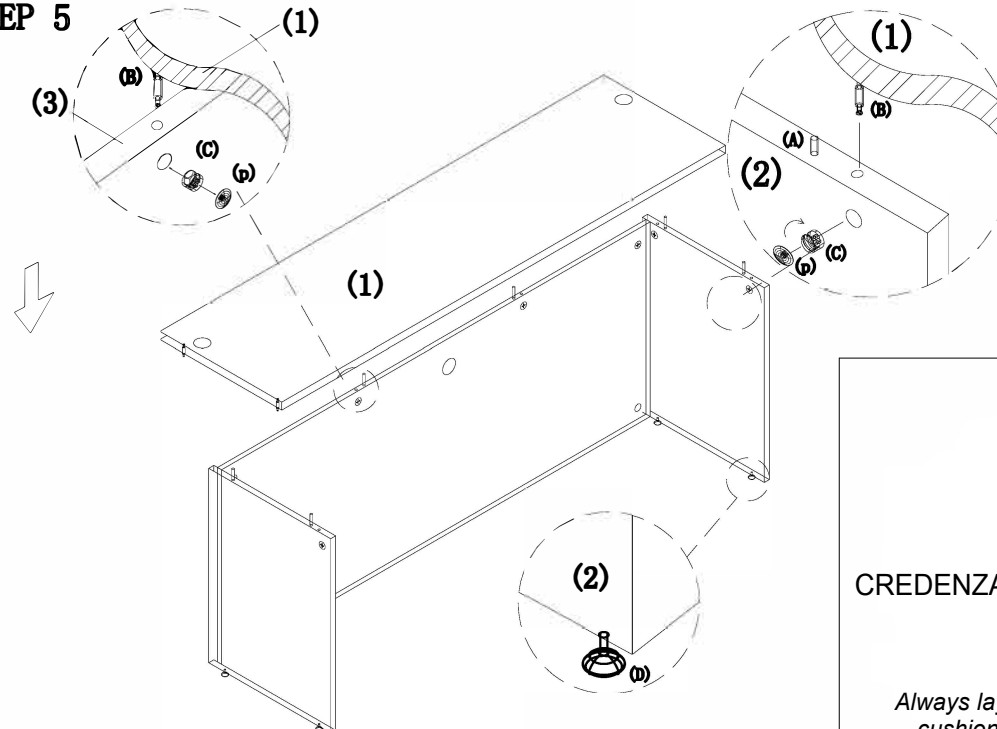

**it.**  
office furniture distributors

CREDENZA SHELL 71"W x 24"D x 29"H  
**N43**

*Always lay components on a clean, soft-cushioned surface during assembly.*