

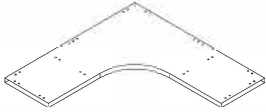

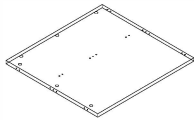

(1) Top  1PCS	(2) End Panel  1PCS	(3) End Panel  1PCS	(4) End Panel  1PCS	(5) End Panel  1PCS	(6) Center Support  2PCS	(7) Door  2PCS	(8) Shelf  1PCS
(M) Cushion  5PCS+1	(M1) Cushion  2PCS	(E0) Wood Screw  28PCS+2	(A) Dowel  44PCS+2	(B) Cam Pin  37PCS+2	(C) Cam Lock  37PCS+2	(p) Cam Cover  37PCS+2	(R) Flat Bracket  2PCS

STEP 1

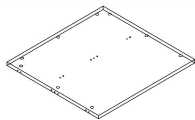
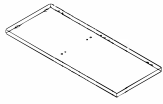
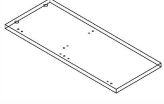
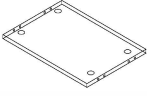
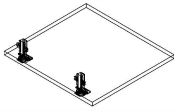
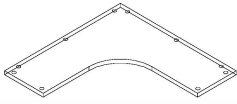
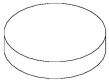

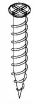
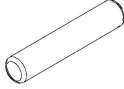
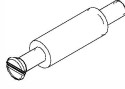
STEP 2

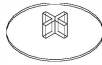
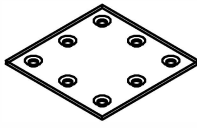
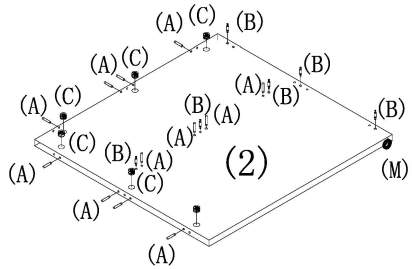
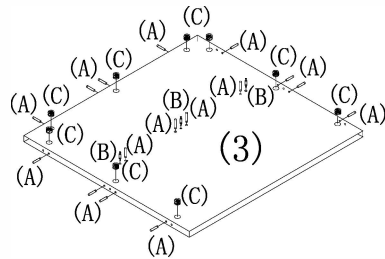

STEP 3

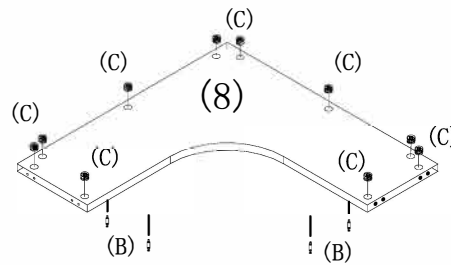

STEP 7

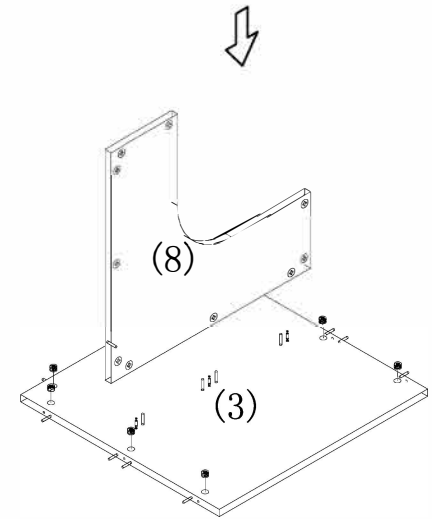

STEP 4

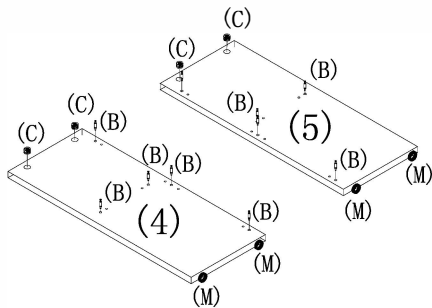

STEP 5

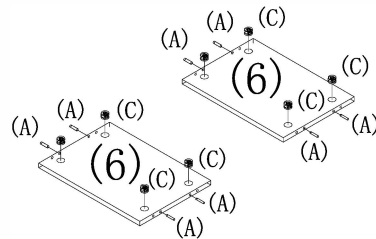

STEP 6

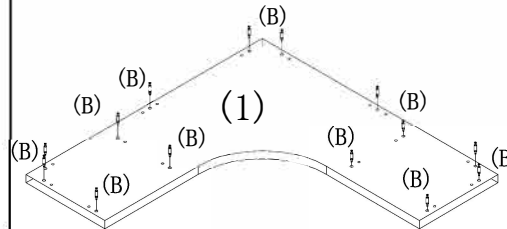

**it.**  
office furniture distributors

**CORNER HUTCH 42"W x 42"D x 36"H**

**N84**

*Always lay components on a clean, soft-cushioned surface during assembly.*

STEP 8

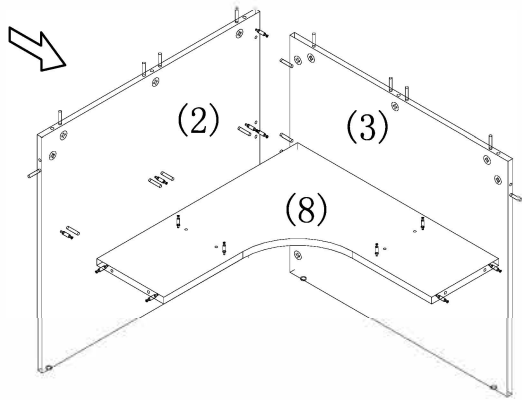

STEP 9

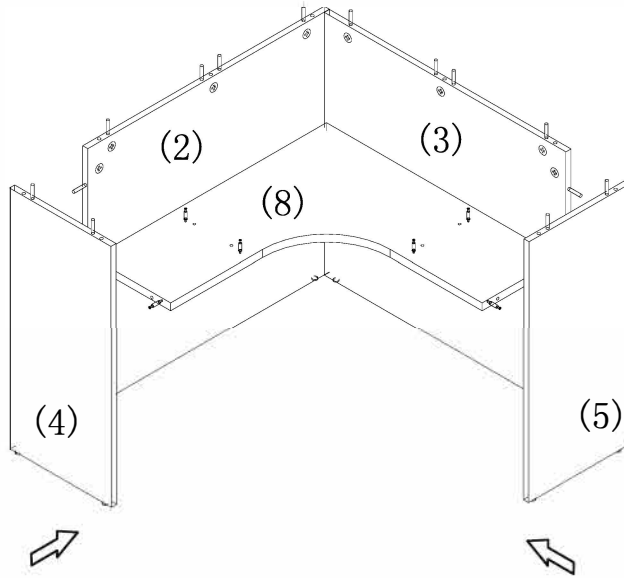

STEP 12

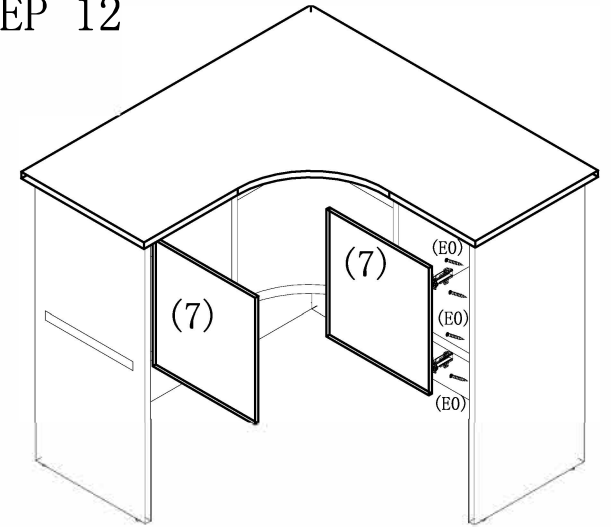

STEP 10

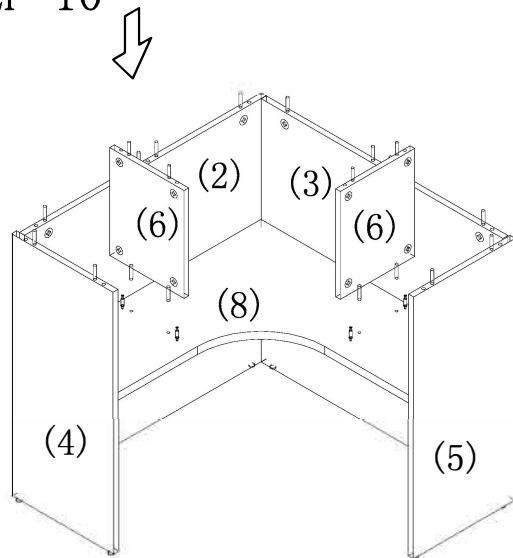

STEP 11

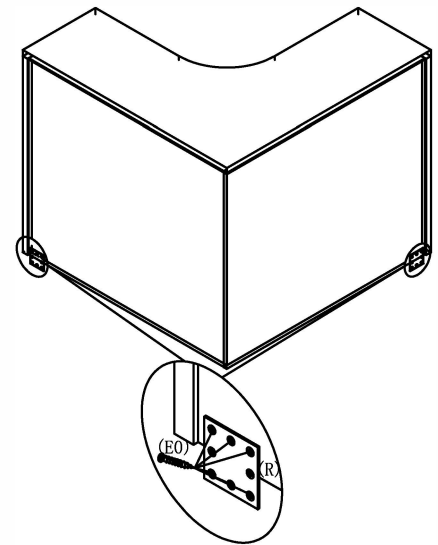
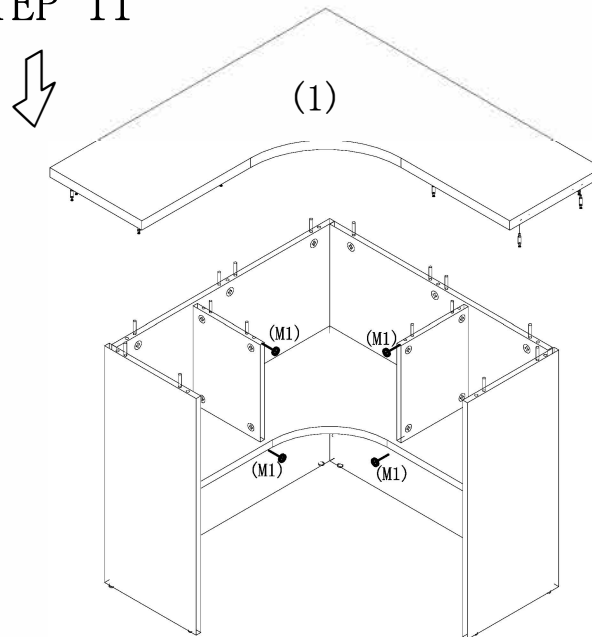

**it.**  
office furniture distributors

CORNER HUTCH 42"W x 42"D x 36"H

**N84**

*Always lay components on a clean, soft-cushioned surface during assembly.*